

# Fault tolerant control of two tanks system using gain-scheduled type-2 fuzzy sliding mode controller

Keltoum Loukal<sup>1</sup>, Abderrahmen Bouguerra<sup>1</sup>, Samir Zeghlache<sup>2</sup>

<sup>1</sup>LGE Research Laboratory, Department of Electrical Engineering, Faculty of technology, University of M'sila, M'sila, Algeria

<sup>2</sup>LASS Research Laboratory, Department of Electronics, Faculty of technology, University of M'sila, M'sila, Algeria

## Article Info

### Article history:

Received Sep 4, 2022

Revised Oct 22, 2022

Accepted Dec 21, 2022

### Keywords:

Fault tolerant control gain-scheduled type 2 fuzzy sliding mode controller

Gain-scheduled

Sliding mode control

Two tanks system

Type 2 fuzzy logic control

## ABSTRACT

To save the robustness of type 2 fuzzy logic control technique and to avoid the high energy consumption that represents the sliding mode control (SMC) technique control technique, without failing the performance of the system, we propose a new fault tolerant control method based on gain-scheduled sliding mode control with interval type 2 fuzzy logic (FTCGST2FSMC) applied to the hydraulic system (two tanks system) with an actuator fault. The proposed control scheme avoids a difficult modeling, due to the chatter effect of the SMC, guarantees the stability studied by Lyapunov with the robustness of the system. The gains of the control with the SMC controller are modified and changed by an adaptation with a technique based on type 2 fuzzy logic, used to improve the gains of the controller when the fault is added, the proposed FTCSG2FSMC controller has been compared with the sliding mode controller. The results obtained confirm the robustness and the performance of this method, in the presence of the actuator fault effect.

*This is an open access article under the [CC BY-SA](https://creativecommons.org/licenses/by-sa/4.0/) license.*



## Corresponding Author:

Keltoum Loukal

Department of Electrical Engineering, Faculty of Technology, University Mohamed Boudiaf of M'sila

BP 166 Ichbilia 28000, Algeria

Email: keltoum.loukal@univ-msila.dz

## 1. INTRODUCTION

With the process complexity and the increase in hardware or software technological elements that are often integrated into the control loops of nonlinear systems, fault tolerance control (FTC) has become one of the major concerns in the design of these systems [1]. A fault can be defined as a deviation, undesirable, or degradation of the characteristic and parametric properties of the system. A fault can appear in different parts of the system, malfunction, or total loss of the system. Three classes of faults can be defined, faults in the actuator, system components, or sensor faults [2]. Synthesis methods for FTC systems are generally classified into two main families: passive approaches (passive FTC systems: PFTCS) [3], [4] and so-called active approaches (active FTC systems: AFTCS) [5]. Passive methods are equivalent to robust control law synthesis methods. Active methods are generally classified into three subclasses: fault accommodation, system reconfiguration, and restructuring [1]. Research areas in recent years have been directed towards level control of single-tank or coupled multi-tank hydraulic systems, due to their great importance and many important uses. A large number of researchers have directed their research to passive or active liquid level FTC in the case of system, actuator, or sensor faults of a coupled tank system [6]. FTC control use a lot of control methods to achieve fault tolerance [6], the system is controlled from the distribution and disposal, in practical logic, in relative instructions examined in different degrees, in [7] propose a method of detecting and isolating the faults of the FTC control in the sensor part, based on the integration of the first farthest travel algorithm method originating from the data mining with data-based controls. statistical analysis, from the use of the window slip

technique to detect changes in control signals, many applications work on fuzzy logic (FL) [8], Himanshukumar in [9] used the FTC in the case of actuator and system faults, based on the technique of Takagi-Sugeno FL type 1 and 2 of the three reservoirs system, the author offers a control system inference method based on this Sugeno-type method. Fuzzy logic in the case where the priors are type 1 and type 2 fuzzy controls with FTC control applications for the case of servo control with or without fault and control in the regulation loop with the three types of faults. The work in [5] and [10] used an active fault accommodation method, fault detection and isolation (FDI) approach. This FDI approach is based on a prototype by fuzzy logic which represents the system power and the representation of faults with this prototype in the studied system applied to the three reservoirs system. In this study [11] a passive FTC (PFTC) with the comparison between classical proportional-integral (PI) and fuzzy controls, the objective is to design a PFTC for a single tank level system with the system (leakage) and sensor faults. FL is used to develop an FTC system. The practice of the artificial intelligence was effective in identifying designs and analyzing faults in systems [12]. Himanshukumar and Vipul [13] proposed a new fractional order controller based on type-2 FL with actuator and system (leakage) faults represented by an additive model. The artificial intelligence represented by the technique of the interval type 2 fuzzy logic (IT2FL) is used to create a fractional and optimal order fuzzy control system, and the tracking pollination algorithm with another genetic algorithm, the authors use these algorithms to optimize the gains of the proportional-integral-derivative (PID) controller. In [14] planned a method of passive control based on the theory of artificial intelligence represented by the type 1 and type 2 fuzzy controls of the one or two tank system, the authors in [15] proposed the interval type 2 fuzzy sliding mode (IT2FSM) for chaos coordination applied to uncertain chaotic systems, the gains can be changed in real time in the output feedback and the adaptive laws. It adjusted by the tradeoff between plant knowledge and control knowledge, from indirect adaptive IT2FSM controller and direct adaptive IT2FSM controller, in [16], [17] integrate the Backstepping with IT2FSM to controlled the twin rotor multi-input multi-output (MIMO) system (TRMS) in the presence of external disturbances. Almost with the same ideas, the work of [18] introduces a controller technique based on (IT2FLC), used in the photoelectric system to advance accuracy and steady-state robustness. The IT2FLC is used as an integrator gain control to regulate the on-off to access the dynamic switching type objective. We find many applications for this hybridation technique IT2FSM with or without combine with another artificial intelligence technique like Neural Network Interval, Backstepping, feedback linearization [19]–[24].

The FTC based on the first sliding mode control (SMC) technique is presented by Rafi and Peng [25] the objective is to perform this technique when the fault is integrated in the equivalent control of the SMC. The articles with Bouguerra *et al.*, Zulfatman and Rahmat present adaptive methods of PID controller gains applied on a hydraulic system and a vertical flight system, respectively, the authors use artificial intelligence represented by FL and another method based on Luapunov theory [26]–[28], in [29] a fault-tolerant control system for controlling a quadcopter type aircraft with a faulty model with an actuator type fault is proposed in this work. The FTC in this case is based on the IT2FSM controller used to stabilize the quadcopter.

In order to achieve the main objective of the work, the contribution of this paper is the application of the passive fault tolerant control using the the gain-scheduled based on the hybrid control between of sliding mode with the interval type 2 fuzzy logic (FTCGST2FSMC), Since this controller with gain adaptation is the newest to determine controller gains, the proposed FTCSF2S method was compared with sliding mode control without gain adaptation. This article is divided into five parts; mathematical modeling of the two tanks system is presented in section 2. Section 3 explains the FTCSF2S controller method. The simulation results to validate the robustness of the proposed approach is presented in section 4. Finally, the conclusion in the present paper is driven.

## 2. MATHEMATICAL MODELLING OF THE TWO TANKS SYSTEM

This hydraulic system Figure 1 is composed of two reservoirs connected by a flow channel, a rotary valve serving to change the section of the channel and to convert the flow characteristics between the reservoirs [30]. The inlet of the two-tank system is associated by a variable-speed pump which releases water into tank 1. The two equilibrium equations are given by,

$$\begin{cases} \frac{dh_1}{dt} = \frac{1}{c}(-q_{12} + q_1) \\ \frac{dh_2}{dt} = \frac{1}{c}(q_{12} - q_0) \end{cases} \quad (1)$$

where  $q_0 = c_2\sqrt{2gh_2}$ ,  $q_{12} = c_{12}\sqrt{2g(h_1 - h_2)}$  for  $h_1 > h_2$ ,  $c_2 = s_2 \cdot a_2$  and  $c_{12} = s_{12} \cdot a_{12}$ .

with  $h_i(t)$ : the level of the fluid in the reservoir  $i$ ,  $C$ : the section of the two tanks 1 and 2,  $q_1$ : the inlet flow generated by the pump,  $q_{12}$ : the movement between the two tanks,  $q_0$ : the flow rate out of tank 2,  $c_{12}$ : the part

of the coupling opening,  $c_2$ : the area of the outlet orifice,  $g$ : the gravitation constant,  $s_{12}$ : the channel of section 1,  $s_2$ : the channel of section 2, and  $a_{12}$ ,  $a_2$  the release constants of valve 1 and valve 2, respectively.

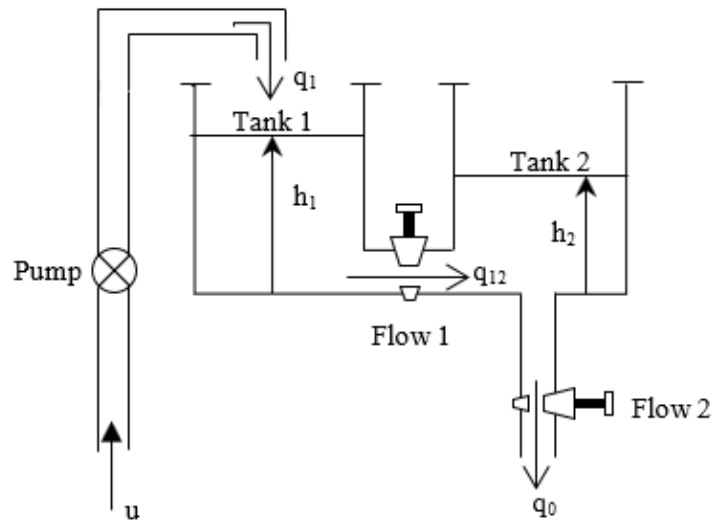

Figure 1. Hydraulic system with combined reservoirs [30]

For the coupled reservoir system, the inlet fluid flow,  $q_1 \geq 0$  is always positive, because the pump is continuously pumping water into tank 1. Lastly, the nonlinear model is given by,

$$\begin{cases} \frac{dh_1}{dt} = \frac{1}{c} (-s_{12} \cdot a_{12} \sqrt{2g(h_1 - h_2)} + k_p \cdot u) \\ \frac{dh_2}{dt} = \frac{1}{c} (s_{12} \cdot a_{12} \sqrt{2g(h_1 - h_2)} - s_2 \cdot a_0 \sqrt{2gh_2}) \end{cases} \quad (2)$$

$$y = h_2 \quad (3)$$

With  $y$  is the output of our system. Were,

$$u = \begin{cases} u_{\max} & \text{if } u \geq u_{\max} \\ 0 & \text{if } u \leq 0 \end{cases} \quad (4)$$

For this system, we define the state model [30], with,

$$x = \begin{bmatrix} x_1 \\ x_2 \end{bmatrix} = \begin{bmatrix} h_2 \\ h_1 \end{bmatrix} \quad (5)$$

such as,

$$\dot{x} = \begin{cases} \dot{x}_1 = \alpha_1 \cdot \sqrt{x_2 - x_1} - \alpha_2 \cdot \sqrt{x_1} \\ \dot{x}_2 = -\alpha_1 \cdot \sqrt{x_2 - x_1} + k_c \cdot u \end{cases} \quad (6)$$

$$y = x_1 \quad (7)$$

$$\text{and } \alpha_1 = \frac{s_{12} \cdot a_{12} \sqrt{2g}}{c}; \alpha_2 = \frac{s_2 \cdot a_2 \sqrt{2g}}{c}; k_c = \frac{k_p}{c}$$

### 3. SLIDING MODE CONTROL DESIGN

In control of systems, Variable structure or sliding mode control (SMC) is a robust nonlinear control method that alters the dynamics of a system by applying a discontinuous control signal that causes the system

to "slide" along a cross section, this technique is based on the switching of state variable functions used to create the sliding surface [31], [32]. The state feedback command law is not a continuous equation of time. Instead, it can hurdle from the first continuous structure to another related with the current position.

In the first step we can choose the sliding surface as a linear function or nonlinear expression [33], [34]. which is written as a function of its degree and the deviation of the output from its desired value. It is sufficient that the vector  $[\lambda_1 \dots \lambda_{n-1}]$  generates a Hurwitz polynomial so that the SM is asymptotic steady, the nonlinear surface is that of Slotine [33]. The sliding surface and the surface of slotine are given by,

$$s(x) = \sum_{i=1}^{i=n} \lambda_i e_i \quad (8)$$

$$s = \left(\frac{d}{dt} + \lambda\right)^{n-1} \quad (9)$$

The particular polynomial of the surface of Slotine [34], is  $s = (1 + \lambda)^{n-1}$ , where  $\lambda$  is constant positive value, the tracking error is  $e = (x - x_d)$  and  $x_d$  is the trajectory reference. we explain the Lyapunov purpose with,

$$V(x) = \frac{1}{2} S(x)^2 \quad (10)$$

To guarantee the solidity of the system, we will choose the Lyapunov purpose in a way that decreases over time, so the conditions given by,

$$\dot{V}(s) = s \cdot \dot{s} < -k \cdot |s| \quad \text{ou} \quad \dot{V}(s) < -k \cdot \text{sign}(|s|) \quad (11)$$

such as  $k > 0$ . To reduce the chatter phenomenon, we replace the *sign* function by a *sat* saturation function. In the second step we calculate the control law with two components: an equivalent component  $u_{eq}$  (that is deduced from the condition  $\dot{S}(x) = 0$ ) proposed by Slotine and Li [33], and another component  $u_{att}$  which is added as an auxiliary command to guarantee the attractiveness of the sliding surface,

$$u = u_{eq} + u_{att} \quad (12)$$

#### 4. GENERAL INFORMATION ON TYPE-2 FUZZY LOGIC

The idea of type 2 fuzzy logic sets was introduced by Zadeh as an extension of type 1 fuzzy logic. So, the difference characterized in the inference part, choosing us as numbers in the interval [0-1] [35]. A type-1 fuzzy set is characterized by a two-dimensional membership function, whereas a type-2 fuzzy set is characterized by a three-dimensional membership function. Below we highlight the five steps that explain the type 2 fuzzy logic.

##### 4.1. Fuzzifier

A fuzzifier gives ordinary non-fuzzy input into fuzzy sets. These fuzzy sets can in general remain of type-2, therefore, we will consider in our paper a singleton type fuzzification for which the single-point fuzzy input whose membership value is non-zero. The type 2 membership function distributed several memberships ranks when comparing with the type 1 membership functions for all inputs then, one can represent the uncertainty with superior [36].

##### 4.2. Rules

The difference between the membership functions of the two types of fuzzy logic resides only in their natures of these functions; therefore, the composition of the rules remains the same for both types of fuzzy logic, so the difference lies in the nature of the membership functions; then, the  $j^{\text{th}}$  rule of a type-2 fuzzy logic will have the procedure,

$$\text{Si } x_1 \text{ is } \tilde{F}_1^j \text{ and } x_2 \text{ is } \tilde{F}_2^j \text{ and } x_n \text{ is } \tilde{F}_n^j \text{ then } y = \tilde{G}^j \quad (13)$$

Where:  $x_i (i = 1, \dots, n)$  are the entries of the fuzzy method,  $\tilde{F}_i^j$  is the type-2 fuzzy set conforming to the input  $x_i$ ,  $\tilde{G}^j$  is a type-2 singleton and  $y$  is the output. In this case the functions of membership are not obligatory of the same premises and consequences [31].

**4.3. Inference engine**

As only the fuzzy type-2 sets are worn out and the product t-norms operation is applied, then the activation domain associated with the  $l^{th}$  output fuzzy set is the interval type-1 fuzzy set represented by,

$$F^l(x) = [f^l(x), \bar{f}^l(x)] \tag{14}$$

where  $f^l = \underline{\mu}_{\bar{F}_1^l}(x_1) * \underline{\mu}_{\bar{F}_2^l}(x_2) * \dots * \underline{\mu}_{\bar{F}_n^l}(x_n)$  and  $\bar{f}^l = \bar{\mu}_{\bar{F}_1^l}(x_1) * \bar{\mu}_{\bar{F}_2^l}(x_2) * \dots * \bar{\mu}_{\bar{F}_n^l}(x_n)$ . Terms  $\underline{\mu}_{\bar{F}_i^l}(x_i)$  and  $\bar{\mu}_{\bar{F}_i^l}(x_i)$  are respectively the lower and upper membership degrees relative to  $\mu_{\bar{F}_i^l}(x_i)$  [37].

**4.4. Type reducer**

Like the type 2 fuzzy logic inference output, so it must restrict its type before the last defuzzification step to produce a real output. This is the main difference between the two types of fuzzy logic [36]. The expression of the  $GC_{\bar{A}}$  type fuzzy set is defined by,

$$GC_{\bar{A}} = \int_{z_1 \in Z_1} \dots \int_{z_n \in Z_n} \int_{w_1 \in W_1} \dots \int_{w_n \in W_n} \frac{[T_{i=1}^n \mu_Z(z_i) * T_{i=1}^n \mu_W(z_i)]}{\sum_{i=1}^n z_i w_i / \sum_{i=1}^n w_i} \tag{15}$$

with  $T$  and  $*$  indicate the chosen t-norm (prod or min).  $w_i \in W_i$  and  $z_i \in Z_i$  for  $i=1,2, n$ .

$$GC_{\bar{A}} = \int_{y_l \in [y_l^1, y_l^1]} \dots \int_{y_M \in [y_l^M, y_r^M]} \dots \int_{f^1 \in [f^1, \bar{f}^1]} \dots \int_{f^M \in [f^M, \bar{f}^M]} \sum_{i=1}^M f^i / \sum_{i=1}^M f^i y^i \tag{16}$$

**4.5. Defuzzifier**

For a type-2 fuzzy system, each output set of a rule is of type-2. In this context, there are generalized versions of defuzzification methods that can provide us with a type-1 set from the type-2 output sets. We call this operation “Type reduction” instead of defuzzification, and we call the resulting type-1 set “Reduced set”. The defuzzifier in a type-2 fuzzy system can then defuzzify the reduced set to obtain an ordinary non-fuzzy output for the type-2 fuzzy system. The summary type (16) will be solved by its two extreme right and left points  $y_l$  and  $y_r$  respectively.

$$y(x) = (y_l(x) + y_r(x))/2 \tag{17}$$

where:  $y_l(x) = \sum_{i=1}^M f_l^i y_l^i / \sum_{i=1}^M f_l^i$  and  $y_r(x) = \sum_{i=1}^M f_r^i y_r^i / \sum_{i=1}^M f_r^i$ .

**5. INTERVAL TYPE-2 FUZZY SLIDING MODE CONTROLLER DESIGN**

One of the main disadvantages of SMC is the chatter phenomenon, as it can loss the actuators with too recurrent solicitations. To minimize these oscillations, numerous solutions have been provided, such as gain adaptation  $k$  of the discontinuous control  $u_{att} = -k_{FT2} u_{att}$  with a continuous interval type-2 fuzzy logic control. The configuration of the method (FTCGST2FSMC) structure is exposed in Figure 2,

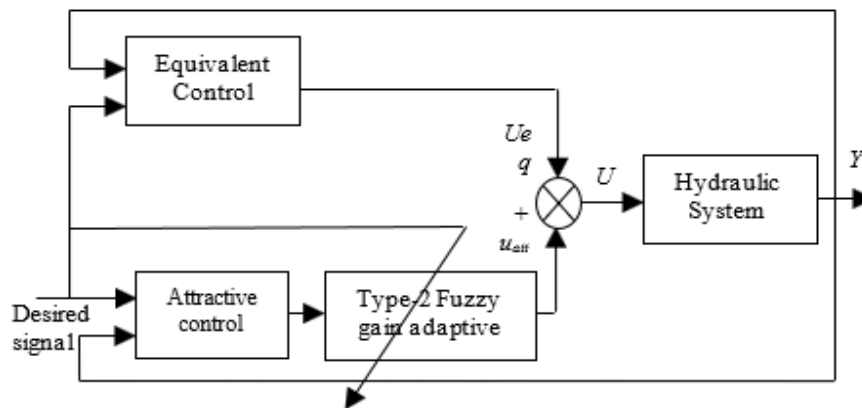

Figure 2. The structure of the FTCGST2FSMC controller

where  $u_{eq}$ : represents the equivalent controller of SMC,  $u_{att}$  is the discontinuous controller of SMC,  $u$  is the FTCSG2FSMC control. The membership functions of the fuzzy logic of the input, the error and the output  $k$  are obtainable by Figure 3,

With NB: negative big, NM: negative medium, EZ: about zero, PM: positive medium and PB: positive big. The table of fuzzy rules which to be used or inference mechanism is given by,

$$\left\{ \begin{array}{l} R1: \text{if } e \text{ is } NG \text{ then } k \text{ is } PB \\ R2: \text{if } e \text{ is } NM \text{ then } k \text{ is } PM \\ R3: \text{if } e \text{ is } EZ \text{ then } k \text{ is } EZ \\ R4: \text{if } e \text{ is } PM \text{ then } k \text{ is } NM \\ R5: \text{if } e \text{ is } PB \text{ then } k \text{ is } NB \end{array} \right. \quad (18)$$

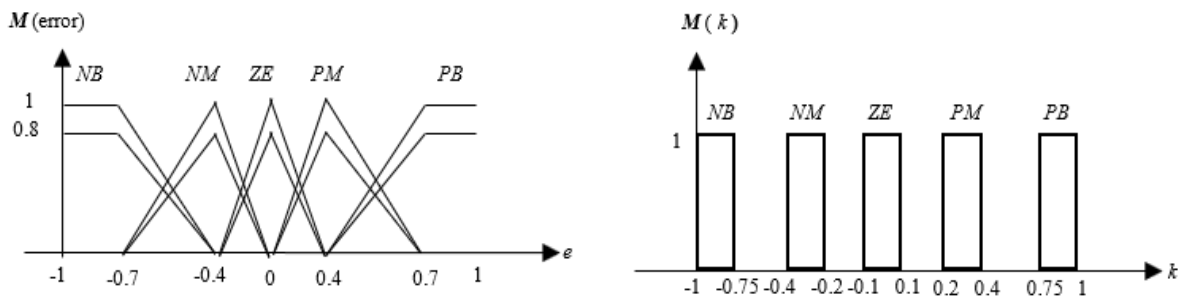

Figure 3. The membership functions of the input error and the output  $k$

The membership functions of the input error and the output, gain  $k$  has been regularized in the interval  $[-1, +1]$ . And for the stability analysis, when the gain adaptive is negative, the condition  $\dot{V}(s) = s \cdot \dot{s} < 0$  would be satisfied automatically. So, the membership functions of the output discontinuous control could be modified with negative or even positive *sign* to achieve healthier performance.

### 6. CONTROL STRATEGY OF THE HYDRAULIC SYSTEM IN THE PRESENCE OF THE ACTUATOR FAULT

The dynamics mathematic model (2) of the the two tanks system exposed in the initial part of this article can be written with,

$$\dot{x} = f(x, t) + g(x, t) u_{fa} \quad (19)$$

where  $u_{fa} = u + f_a(t)$  and  $f_a(t)$  is the actuator fault, with  $|f_a(t)| < |u_{max}|$ .

The actuator fault is assumed to be additive and modeled by an increase of  $H\%$  in the control signals (*rect*). We assume that the fault appears at time  $t = 125$  s and disappears at time  $t = 135$  s as shown in Figure 4.

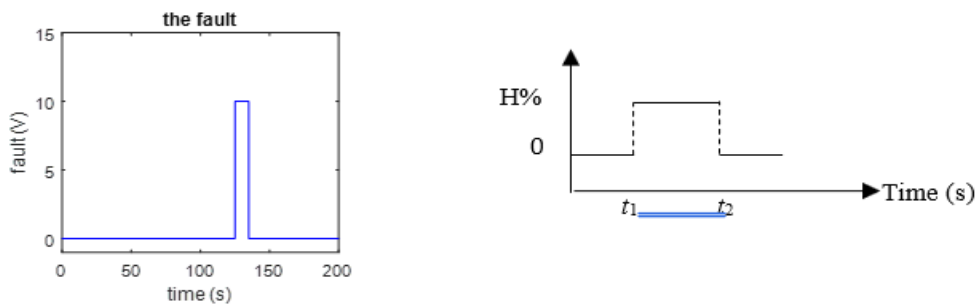

Figure 4. Type of the actuator fault added to command  $u$

The function can be considered as a signal,

$$f_a(t) = H \cdot \text{rect}\left(\frac{t-\tau}{T}\right) = u(t - t_1) - u(t - t_2) \tag{20}$$

such as *rect*: is the rectangular function, *H*: is the amplitude, *T*: is the fault duration,  $\tau$ : is the center of the rectangular function *rect*, *u*: is the the step function, with:  $t_2 > t_1$ . In the first proposition we Consider the state space defined in (2), and let *V* remain a Lyapunov function  $V = (1/2) * s^2$  and the sliding surface is chosen by  $s = \dot{e} + \lambda \cdot e$ , with  $e = x_1 - x_d$ . To have  $\dot{V} = s \cdot \dot{s}$  negative, it suffices that:  $s \cdot \dot{s} < 0$ ,

$$\dot{V} = s \cdot \dot{s} = [\alpha_1 \sqrt{x_2 - x_1} - \alpha_2 \sqrt{x_1} - \dot{x}_{1d} + \lambda e] [-\alpha_1^2 + \frac{\alpha_1 k_c}{2\sqrt{x_2-x_1}} u + \frac{\alpha_1 \alpha_2 \sqrt{x_1}}{2\sqrt{x_2-x_1}} - \frac{\alpha_1 \alpha_2 \sqrt{x_2-x_1}}{2\sqrt{x_1}} + \frac{\alpha_2^2}{2} - \dot{x}_{1d} + \lambda \dot{e}] \tag{21}$$

$$\begin{aligned} \dot{V} = & \alpha_1 \sqrt{x_2 - x_1} [\alpha_2^2 - \alpha_1^2 - \dot{x}_{1d} + \lambda \dot{e} + \alpha_2 \frac{[\dot{x}_{1d} - \lambda e]}{2\sqrt{x_1}}] + \frac{\alpha_1 k_c [\alpha_1 - \alpha_2 \sqrt{x_1} - \dot{x}_{1d} + \lambda e]}{2\sqrt{x_2-x_1}} u \\ & + [\frac{3}{2} \alpha_1^2 + \frac{\alpha_2^2}{2} + \lambda \dot{e} + \dot{x}_{1d} + \alpha_1 \frac{[\lambda e - \dot{x}_{1d}]}{2\sqrt{x_2-x_1}}] \alpha_2 \sqrt{x_1} - \frac{\alpha_1^2 \alpha_2}{2\sqrt{x_1}} (x_2 - x_1) - \frac{\alpha_1 \alpha_2^2 x_1}{2\sqrt{x_2-x_1}} + \\ & [\alpha_1^2 - \frac{\alpha_2^2}{2} + \dot{x}_{1d} - \lambda \dot{e}] \dot{x}_{1d} + [\dot{e} + \frac{\alpha_2^2}{2} - \alpha_1^2 - \dot{x}_{1d}] \lambda e \end{aligned} \tag{22}$$

The control law is computed by:  $u = u_{eq} + u_{att}$  and  $u_{att} = -k_1 \cdot s - k_2 \cdot \text{sign}(s)$ , with,

$$\begin{aligned} u = & \frac{2\sqrt{x_2-x_1}}{\alpha_1 k_c [\alpha_1 - \alpha_2 \sqrt{x_1} - \dot{x}_{1d} + \lambda e]} [(-\alpha_1 \sqrt{x_2 - x_1} [\alpha_2^2 - \alpha_1^2 - \dot{x}_{1d} + \lambda \dot{e} + \alpha_2 \frac{[\dot{x}_{1d} - \lambda e]}{2\sqrt{x_1}}]) \\ & - (\frac{3}{2} \alpha_1^2 + \frac{\alpha_2^2}{2} + \lambda \dot{e} + \dot{x}_{1d} + \alpha_1 \frac{[\lambda e - \dot{x}_{1d}]}{2\sqrt{x_2-x_1}}) \alpha_2 \sqrt{x_1} + \frac{\alpha_1^2 \alpha_2}{2\sqrt{x_1}} (x_2 - x_1) + \frac{\alpha_1 \alpha_2^2 x_1}{2\sqrt{x_2-x_1}} - k_1 \cdot s - k_2 \cdot \text{sign}(s) \\ & - (\alpha_1^2 - \frac{\alpha_2^2}{2} + \dot{x}_{1d} - \lambda \dot{e}) \dot{x}_{1d} + (\dot{e} + \frac{\alpha_2^2}{2} - \alpha_1^2 - \dot{x}_{1d}) \lambda e] \end{aligned} \tag{23}$$

In the second proposition, the gain of the discontinuous control laws is calculated by interval type-2 fuzzy logic inference using the (17), then  $u = u_{eq} + k_{FT2} u_{att}$ .

### 7. SIMULATION RESULTS

In this part of the article, we present the results of the simulations to demonstrate the robustness and the performance of the FTCGST2FSMC when practical to the two reservoirs system. The parameters standards of the hydraulic system as shown in Table 1. Two scenarios are represented in this work. The first scenario in the case of the system response without faults and the second scenario has actuator faults.

Table 1. The parameters of the coupled reservoirs [30]

Definition	Parameter	Value
Section of each tank	<i>C</i>	$9350 \times 10^{-6} m^2$
Section of the variable opening of each valve	<i>s<sub>12</sub></i>	$78.5 \times 10^{-6} m^2$
	<i>s<sub>2</sub></i>	$78.5 \times 10^{-6} m^2$
Discharge coefficients	<i>c<sub>12</sub></i>	1
	<i>c<sub>2</sub></i>	0.6
Pump gain	<i>k<sub>p</sub></i>	$450 \times 10^{-6} m^3 / s \cdot v$
Sensor gain	<i>k<sub>s</sub></i>	41 v/m
The gravitation constant	<i>g</i>	$9.81 m/sec^2$

#### 7.1. Case 1. Simulation without actuator faults

The simulation results of the SMC and the FTCGST2FSMC hybrid without faults are shown in Figures 5 and 6 for a step reference. it can be seen that the proposed controller (FTCGST2FSMC) provides good trajectory tracking performance and allows us to cancel out the overshoot problem in the transient state when comparing the results with the SMC control.

**7.2. Case 1 simulation with faults**

The actuator faults are expected additive and demonstrated by an increase 45%  $u_{max}$  in command signals, the simulation results of our method in the presence of the actuator faults are given in Figures 7 and Figures 8. From Figures 7 and 8 we notice that, in the case of the regulator (FTCGST2FSMC), when the actuator fault injected into the command  $u$ , the regulation and following errors and the value of the overshoot are low and that there is a respectable following of the desired trajectories and the control signals are relatively smooth, we can also see that the estimated parameters are bounded. whereas in the case of the regulator (FSMC), oscillations with large amplitude are observed, so the regulator (FTCGST2FSMC) reduces the effect of faults on the control performance with rapidly varying the values of the regulator parameters to quickly bring the system outputs to their desired values ( $t=125s$  and  $t=135s$ ). We can see from Figures 5 to 8 that when the actuator faults occur, the value of  $k$  decreases to avoid the overshoot which may be caused by the increase in command  $u$ .

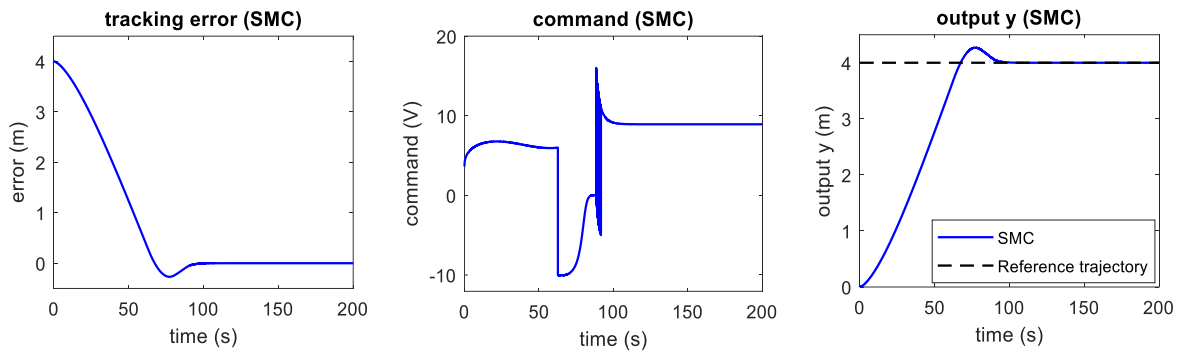

Figure 5. Simulation results of SMC without actuator faults

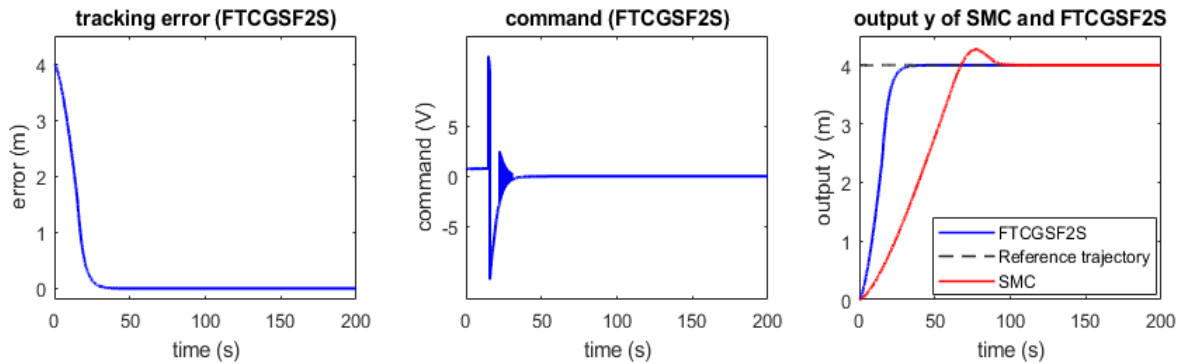

Figure 6. Comparison between the proposed method FTCSGF2S and the SMC without actuator faults

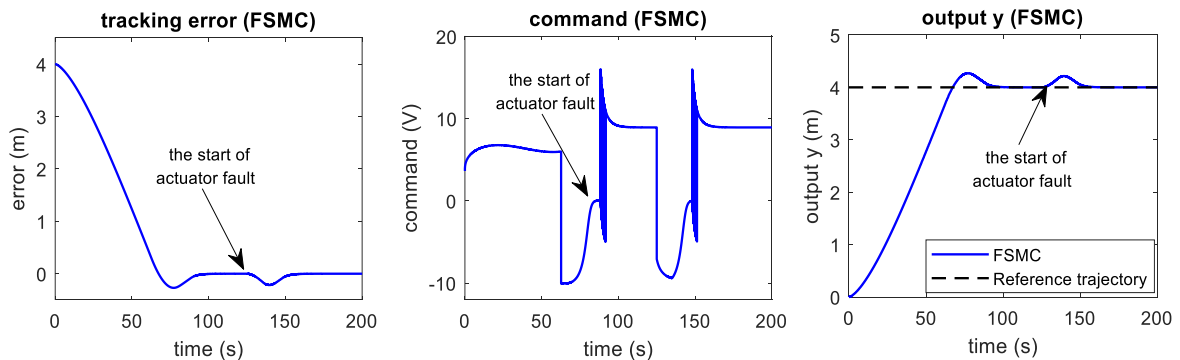

Figure 7. Simulation results of fault sliding mode controller (FSMC) with actuator faults



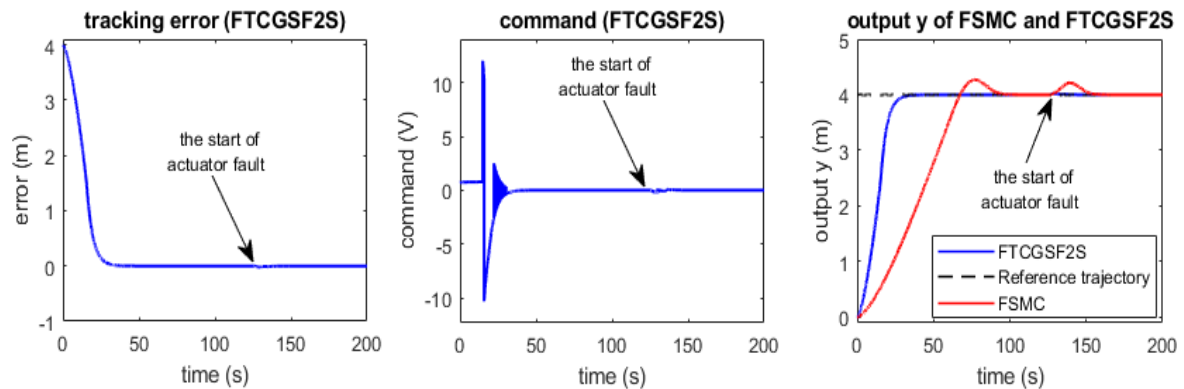

Figure 8. Comparison between the FTCGST2FSMC controller and the FSMC with actuator faults

### 7.3. Comparison between FTCGSF2S and FSMC

To observe the different control laws proposed for this system, we carry out a quantitative comparison between the proposed FTCGST2FSMC and the FSMC, for this we describe three well-known performance criteria which are used [38]. These criteria related with the error, integral of the squared error (ISE), the integral of the absolute value of error (IAE), and the integral of the time multiplied by the absolute value of error (ITAE). The values obtained for each criterion are reduced in Table 2. We note that for the FTCGST2FSMC controller, the ISE, IAE and ITAE criteria take the lowest value, the answers drawn from Table 2 and Figures 5-8 are confirmed with the figure of the comparison, where it is assumed that the FTCGSF2S controller is the best in response time where it is fast and good trajectory following.

Table 2. Values of the performance criteria

	Control method	ISE	IAE	ITAE
without faults	SMC	$5.06 \times 10^3$	$6.13 \times 10^3$	$3 \times 10^4$
	FTCGST2FSMC	$4.47 \times 10^3$	$5.24 \times 10^3$	$2.01 \times 10^4$
with faults	SMC	$6.05 \times 10^3$	$7.11 \times 10^3$	$4 \times 10^4$
	FTCGST2FSMC	$5.44 \times 10^3$	$6.59 \times 10^3$	$3.03 \times 10^4$

## 8. CONCLUSIONS

The work presented in this work summarizes the control of a hydraulic system with two tanks based on the FTCGSF2S regulator in the presence of an actuator fault. This involves developing an adaptive sliding mode control law using type 2 fuzzy logic (adapting the gain of the attractive control  $u_{att}$ ) in order to ensure tracking performance in the case of fault addition, while respecting the analysis of the global stability of the studied system. In a first step, we made a theoretical study with a modeling of this system, then the synthesis of the control by sliding mode with a hybridization by the type 2 fuzzy technique in the event of the presence of an actuator fault. The results obtained show that this regulation by FTCGSF2S presents good performances in terms of disturbance tracking and rejection. The superiority of FTCGSF2S method was confirmed by a comparative study using the three criteria, ISE, IAE and ITAE.

## REFERENCES



- [1] M. Blanke, M. Kinnaert, J. Lunze, and M. Staroswiecki, *Diagnosis and fault-tolerant control*. Springer Berlin Heidelberg, 2006.
- [2] H. Noura, D. Theilliol, J.-C. Ponsart, and A. Chamseddine, *Fault-tolerant control systems*. London: Springer London, 2009.
- [3] L. Wang, W. Zhang, and X. Li, "Fuzzy iterative learning fault tolerant control for batch processes with different types of actuator faults," in *2021 CAA Symposium on Fault Detection, Supervision, and Safety for Technical Processes (SAFEPROCESS)*, Dec. 2021, pp. 1–6, doi: 10.1109/SAFEPROCESS52771.2021.9693654.
- [4] H. Patel and V. Shah, "Fault tolerant control using interval type-2 takagi-sugeno fuzzy controller for nonlinear system," in *Intelligent Systems Design and Applications*, 2020, pp. 150–164.
- [5] L. F. Mendonca, J. M. C. Sousa, and J. M. G. Sa da Costa, "Fault accommodation of an experimental three tank system using fuzzy predictive control," in *2008 IEEE International Conference on Fuzzy Systems (IEEE World Congress on Computational Intelligence)*, Jun. 2008, pp. 1619–1625, doi: 10.1109/FUZZY.2008.4630588.
- [6] S. Raval, H. R. Patel, and V. A. Shah, "Fault-tolerant controller comparative study and analysis for benchmark two-tank interacting level control system," *SN Computer Science*, vol. 2, no. 2, p. 93, Apr. 2021, doi: 10.1007/s42979-021-00489-9.

- [7] U. Altinisik and M. Yildirim, "A new fault tolerant control approach for the three-tank system using data mining," *Computers & Electrical Engineering*, vol. 38, no. 6, pp. 1627–1635, Nov. 2012, doi: 10.1016/j.compeleceng.2012.06.011.
- [8] M. Bahita and K. Belarbi, "Real-time application of a fuzzy adaptive control to one level in a three-tank system," *Proceedings of the Institution of Mechanical Engineers, Part I: Journal of Systems and Control Engineering*, vol. 232, no. 7, pp. 845–856, Aug. 2018, doi: 10.1177/0959651818764205.
- [9] H. R. Patel and V. A. Shah, "Fault tolerant control design based on takagi-sugeno fuzzy logic: application to a three-tank system," *Atlantis Studies in Uncertainty Modelling*, vol. 1, pp. 256–266, Aug. 2019, doi: 10.2991/eusflat-19.2019.38.
- [10] L. F. Mendonça, J. M. C. Sousa, and J. M. G. Sá da Costa, "An architecture for fault detection and isolation based on fuzzy methods," *Expert Systems with Applications*, vol. 36, no. 2, pp. 1092–1104, Mar. 2009, doi: 10.1016/j.eswa.2007.11.009.
- [11] H. R. Patel and V. A. Shah, "Performance comparison of passive fault tolerant control strategy with pi and fuzzy control of single-tank level process with sensor and system fault," *American Journal of Engineering and Applied Sciences*, vol. 12, no. 2, pp. 236–246, Feb. 2019, doi: 10.3844/ajeassp.2019.236.246.
- [12] M. A. Hussain, C. R. C. Hassan, K. S. Loh, and K. W. Mah, "Application of artificial intelligence techniques in process fault diagnosis," *Journal of Engineering Science and Technology*, vol. 2, no. 3, pp. 260–270, 2007.
- [13] H. R. Patel and V. A. Shah, "A metaheuristic approach for interval type-2 fuzzy fractional order fault-tolerant controller for a class of uncertain nonlinear system\*," *Automatika*, vol. 63, no. 4, pp. 656–675, Dec. 2022, doi: 10.1080/00051144.2022.2061818.
- [14] H. R. Patel and V. A. Shah, "Passive fault tolerant control based on interval type-2 fuzzy controller for coupled tank system," in *Proceedings of International Conference on Artificial Intelligence, Smart Grid and Smart City Applications*, Cham: Springer International Publishing, 2020, pp. 145–154.
- [15] T.-C. Lin and M.-C. Chen, "Hybrid adaptive interval type-2 fuzzy sliding mode controller for chaos synchronization of uncertain chaotic systems," in *2010 International Symposium on Computer, Communication, Control and Automation (3CA)*, May 2010, pp. 598–601, doi: 10.1109/3CA.2010.5533757.
- [16] B. Loutfi, Z. Samir, D. Ali, and G. M. Zinelaabidine, "Real time implementation of type-2 fuzzy backstepping sliding mode controller for twin rotor MIMO system (TRMS)," *Traitement du Signal*, vol. 36, no. 1, pp. 1–11, Apr. 2019, doi: 10.18280/ts.360101.
- [17] K. Behih, K. Benmahammed, D. Zehar, A. Cherif, and N. Derbel, "Design of interval type 2 fuzzy adaptive sliding mode control via backsteppin," in *2021 18th International Multi-Conference on Systems, Signals & Devices (SSD)*, Mar. 2021, pp. 1308–1313, doi: 10.1109/SSD52085.2021.9429406.
- [18] S. Qin, C. Zhang, T. Zhao, W. Tong, Q. Bao, and Y. Mao, "Dynamic high-type interval type-2 fuzzy logic control for photoelectric tracking system," *Processes*, vol. 10, no. 3, p. 562, Mar. 2022, doi: 10.3390/pr10030562.
- [19] J. Tavoosi, "A new type-2 fuzzy sliding mode control for longitudinal aerodynamic parameters of a commercial aircraft," *Journal Européen des Systèmes Automatisés*, vol. 53, no. 4, pp. 479–485, Sep. 2020, doi: 10.18280/jesa.530405.
- [20] Z. Wang, L. Ran, B. Kong, X. Jia, L. Liu, and J. Tavoosi, "Suspension system control based on type-2 fuzzy sliding mode technique," *Complexity*, vol. 2022, pp. 1–10, May 2022, doi: 10.1155/2022/2685573.
- [21] J.-H. Hwang, Y.-C. Kang, J.-W. Park, and D. W. Kim, "Advanced interval type-2 fuzzy sliding mode control for robot manipulator," *Computational Intelligence and Neuroscience*, vol. 2017, pp. 1–11, 2017, doi: 10.1155/2017/9640849.
- [22] S. Rawat, B. Jha, M. K. Panda, and J. Kanti, "Interval type-2 fuzzy logic control-based frequency control of hybrid power system using DMGS of PI controller," *Applied Sciences*, vol. 11, no. 21, p. 10217, Nov. 2021, doi: 10.3390/app112110217.
- [23] J. Liu, T. Zhao, and S. Dian, "General type-2 fuzzy sliding mode control for motion balance adjusting of power-line inspection robot," *Soft Computing*, vol. 25, no. 2, pp. 1033–1047, Jan. 2021, doi: 10.1007/s00500-020-05202-1.
- [24] Z. Zhang, Y. Niu, Z. Cao, and J. Song, "Security sliding mode control of interval type-2 fuzzy systems subject to cyber attacks: the stochastic communication protocol case," *IEEE Transactions on Fuzzy Systems*, vol. 29, no. 2, pp. 240–251, Feb. 2021, doi: 10.1109/TFUZZ.2020.2972785.
- [25] Y. Rafi and H. Peng, "Fault tolerant control based on sliding mode control approach with application to water tank system," in *Proceedings of the 26th Chinese Control Conference*, Jul. 2007, pp. 415–418, doi: 10.1109/CHICC.2006.4347341.
- [26] A. Bouguerra, D. Saigaa, K. Kara, and S. Zeghlache, "Fault-tolerant lyapunov-gain-scheduled pid control of a quadrotor UAV," *International Journal of Intelligent Engineering and Systems*, vol. 8, no. 2, pp. 1–6, Jun. 2015, doi: 10.22266/ijies2015.0630.01.
- [27] Zulfatman and M. F. Rahmat, "Application of self-tuning fuzzy PID controller on industrial hydraulic actuator using system identification approach," *International Journal on Smart Sensing and Intelligent Systems*, vol. 2, no. 2, pp. 246–261, Jan. 2009, doi: 10.21307/ijssis-2017-349.
- [28] Y. Guo and T. Yang, "A new type of computational verb gain-scheduling PID controller," in *2010 International Conference on Anti-Counterfeiting, Security and Identification*, Jul. 2010, pp. 235–238, doi: 10.1109/ICASID.2010.5551490.
- [29] A. Saggai, S. Zeghlache, L. Benyettou, and A. Djerioui, "Fault tolerant control against actuator faults based on interval type-2 fuzzy sliding mode controller for a quadrotor aircraft," in *2020 2nd International Workshop on Human-Centric Smart Environments for Health and Well-being (IHSH)*, Feb. 2021, pp. 181–186, doi: 10.1109/IHSH51661.2021.9378754.
- [30] A. Boubakir, F. Boudjema, C. Boubakir, and N. Ikhlef, "Loi de commande par mode de glissement avec une surface de glissement non linéaire appliquée au système hydraulique à réservoirs couplés," in *International Conference on Computer Integrated Manufacturing*, 2007, pp. 1–6.
- [31] S. Zeghlache, K. Kara, and D. Saigaa, "Fault tolerant control based on interval type-2 fuzzy sliding mode controller for coaxial trirotor aircraft," *ISA Transactions*, vol. 59, pp. 215–231, Nov. 2015, doi: 10.1016/j.isatra.2015.09.006.
- [32] J. Liu and X. Wang, *Advanced sliding mode control for mechanical systems*. Berlin, Heidelberg: Springer Berlin Heidelberg, 2011.
- [33] J. J. E. Slotine and W. Li, *Applied nonlinear control*. Englewood cliff, new Jersey, 1991.
- [34] J.-J. E. SLOITINE and J. KARL HEDRICK, "Robust input-output feedback linearization," *International Journal of Control*, vol. 57, no. 5, pp. 1133–1139, May 1993, doi: 10.1080/00207179308934435.
- [35] L. A. Zadeh, G. J. Klir, and B. Yuan, *Fuzzy sets, fuzzy logic and fuzzy systems*, vol. 6. WORLD SCIENTIFIC, 1996.
- [36] Qilian Liang and J. M. Mendel, "Interval type-2 fuzzy logic systems: theory and design," *IEEE Transactions on Fuzzy Systems*, vol. 8, no. 5, pp. 535–550, 2000, doi: 10.1109/91.873577.
- [37] O. Castillo and P. Melin, "A review on the design and optimization of interval type-2 fuzzy controllers," *Applied Soft Computing*, vol. 12, no. 4, pp. 1267–1278, Apr. 2012, doi: 10.1016/j.asoc.2011.12.010.
- [38] S. Zeghlache, D. Saigaa, and K. Kara, "Fault tolerant control based on neural network interval type-2 fuzzy sliding mode controller for octorotor UAV," *Frontiers of Computer Science*, vol. 10, no. 4, pp. 657–672, Aug. 2016, doi: 10.1007/s11704-015-4448-8.



**BIOGRAPHIES OF AUTHORS**

**Dr. Keltoum Loukal**    holds a Doctor of Electrical Engineering degree from Mohamed Boudiaf of M'sila University, Algeria in 2017. She also received his B.Sc. and M.Sc. (Electrical Engineering) from M'sila University, Algeria in 2007 and 2012, respectively. She is currently an associate professor at Electrical Engineering Department in Technology Pole, M'sila University, M'sila, Algeria. His research includes the machine DFIM, fault tolerant control, non-linear system, identification and modeling of systems. She has published many papers in international journals and conferences. From 2014 to 2018. She can be contacted at email: [keltoum.loukal@univ-msila.dz](mailto:keltoum.loukal@univ-msila.dz).



**Pr. Abderrahmen Bouguerra**    received the Professorship and D.Sc. degree (Doctor Habilitatus D.Sc.) in Electronics from Mohamed Boudiaf of M'sila University, Algeria, with the Dissertation "Fault tolerant control of a vertical flight aircraft". He is a Professor of Electronics and Automation in the Graduate Division, Electrical Engineering Department, M'sila, Algeria since 2017. Her research interests are in Type-2 fuzzy logic, neural networks, hybrid PID, FTC and sliding mode fuzzy hybrid approaches., He is currently the President of the Scientific Committee of Electrical Engineering Department, Faculty of technology, University Mohamed Boudiaf of M'sila, Algeria. He can be contacted at email: [abderrahmen.bouguerra@univ-msila.dz](mailto:abderrahmen.bouguerra@univ-msila.dz).



**Pr. Samir Zeglache**    received the Professorship and D.Sc. degree (Doctor Habilitatus D.Sc.) in Electronics from Mohamed Boudiaf of M'sila University, Algeria, with the Dissertation "Nonlinear control of a vertical flight aircraft". He is a Professor of Electronics and Automation in the Graduate Division, Electrical Engineering Department, M'sila, Algeria since 2016. Her research interests are in Type-2 fuzzy logic, neural networks, hybrid PID, FTC and sliding mode fuzzy hybrid approaches. He has published many papers in international journals and conferences. From 2010 to 2022. He can be contacted at email: [Samir.zeglache@univ-msila.dz](mailto:Samir.zeglache@univ-msila.dz).